



To be or not
to be?



How to address
global wealth
inequality and
ecological
collapse?





Green growth Ecomodernism



Is it possible?



Most likely,
it's not.



Green LA

Green Zürich
Green Paris

green sacrifice zones

GREEN EXTRACTIVISM

Green growth remains
a theoretical
possibility,
but what if it is never
realized?



Plan B



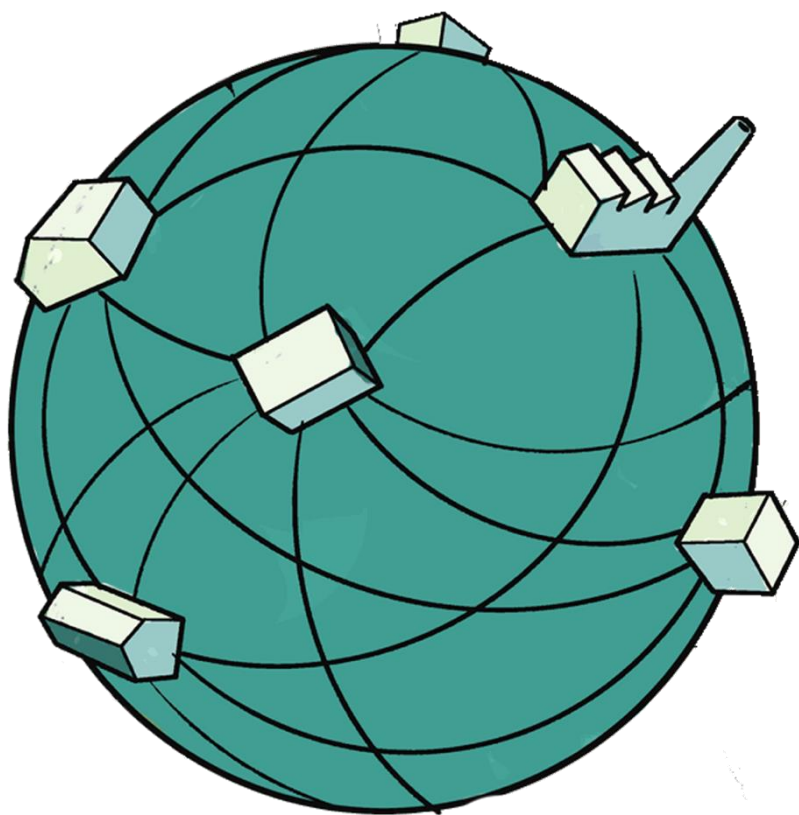

commons

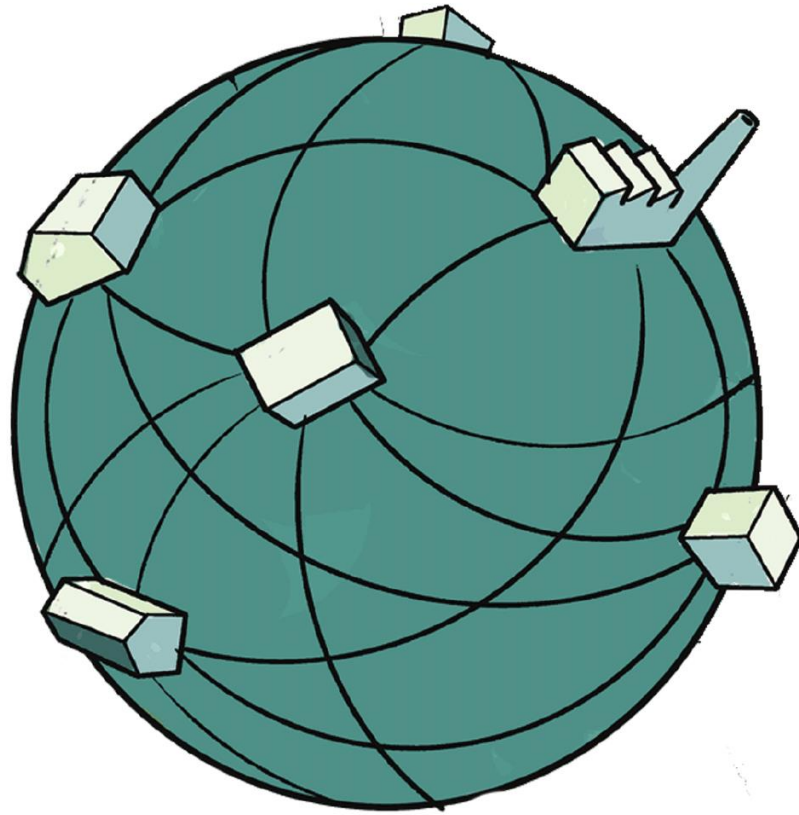

commons

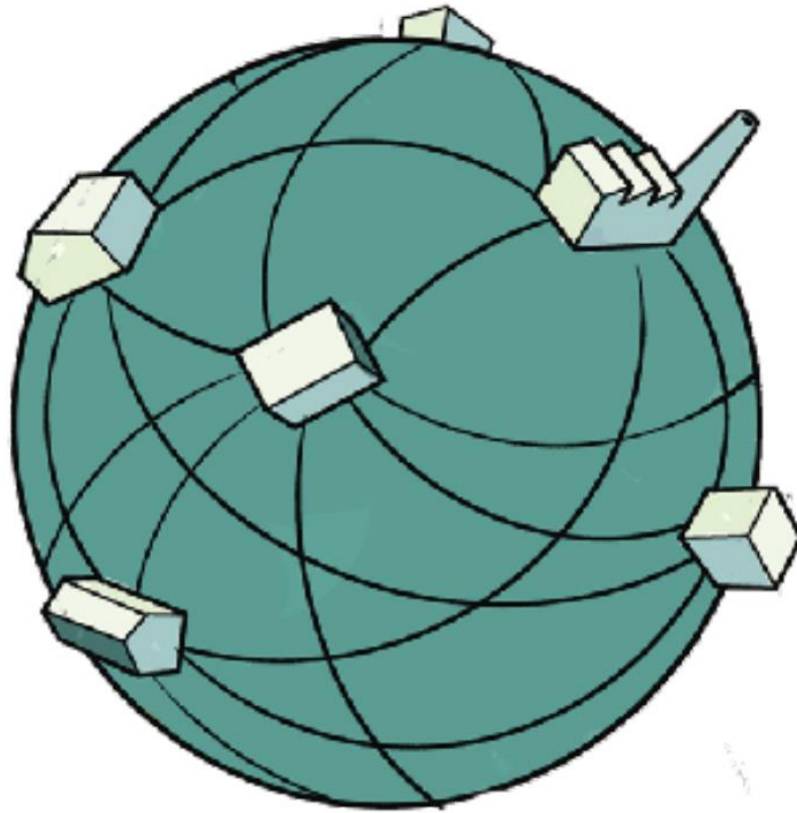

cosmolocalism

software



ॐ

ॐ

Ω

वी

維

ॐ

ॐ





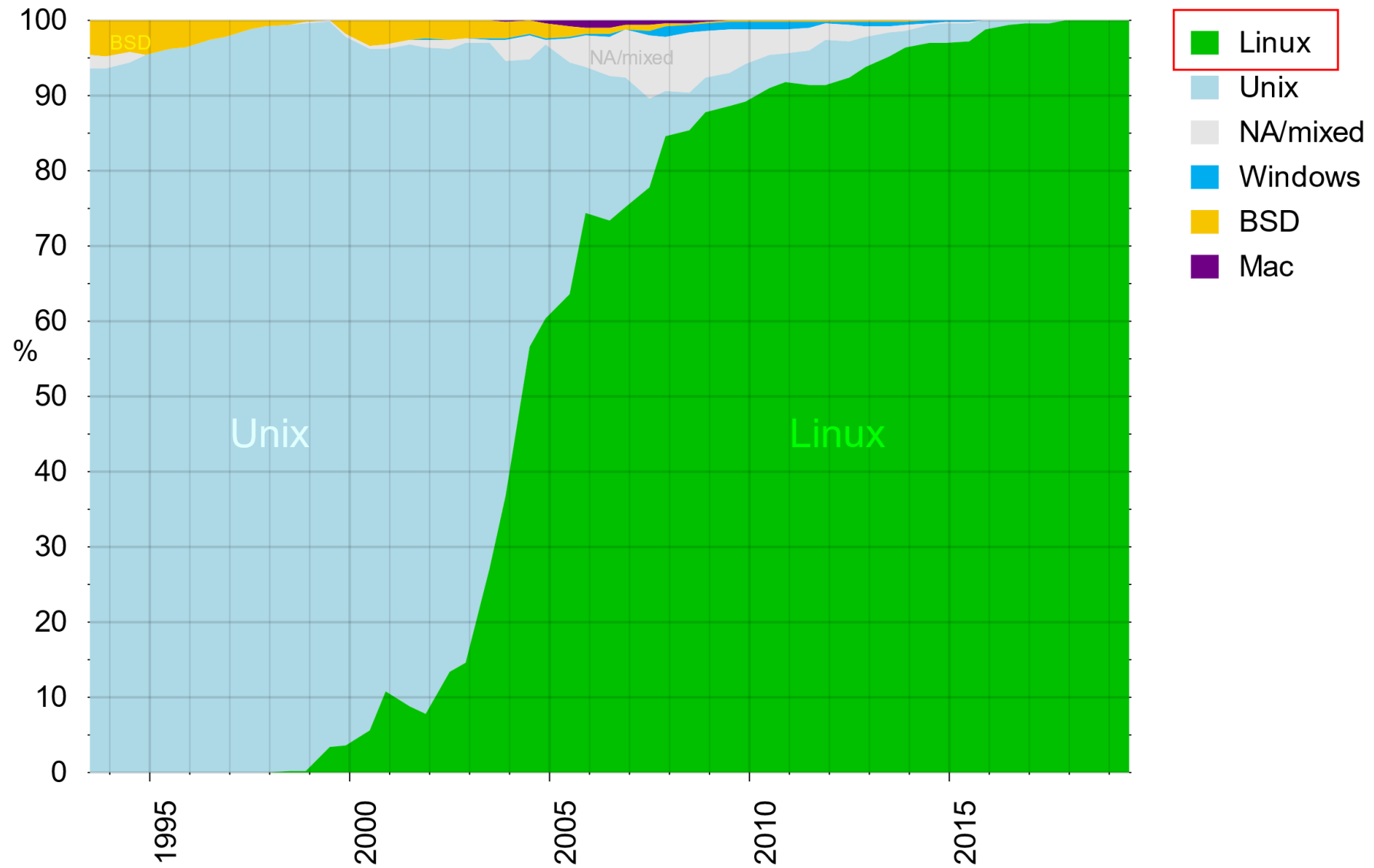

hardware

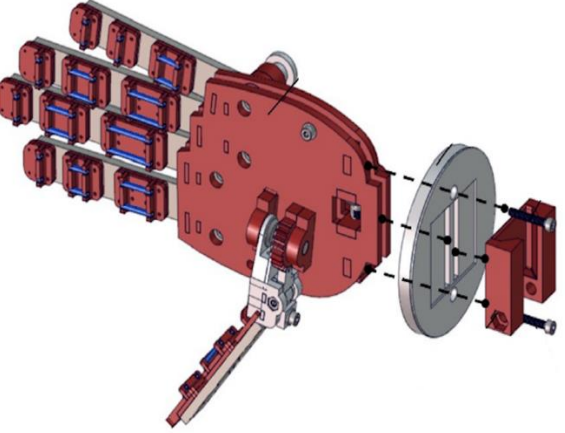

Digital
commons

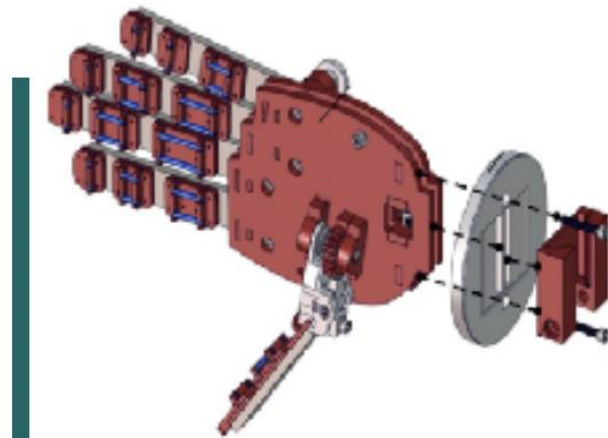

Digital
commons

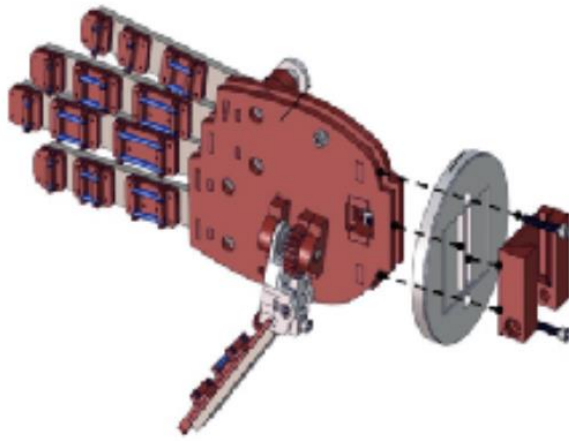

Localized
manufacturing

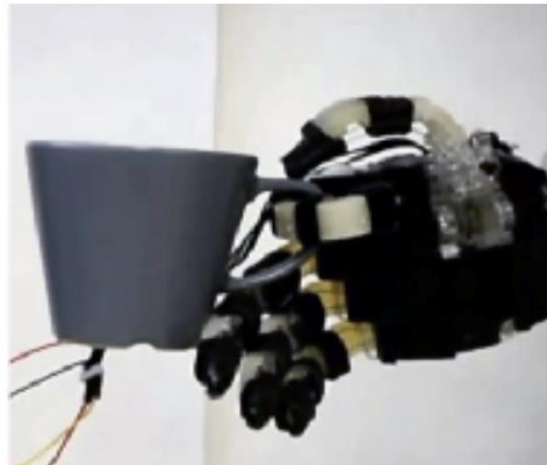
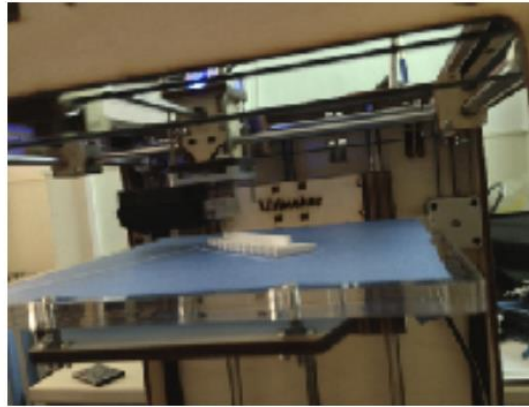

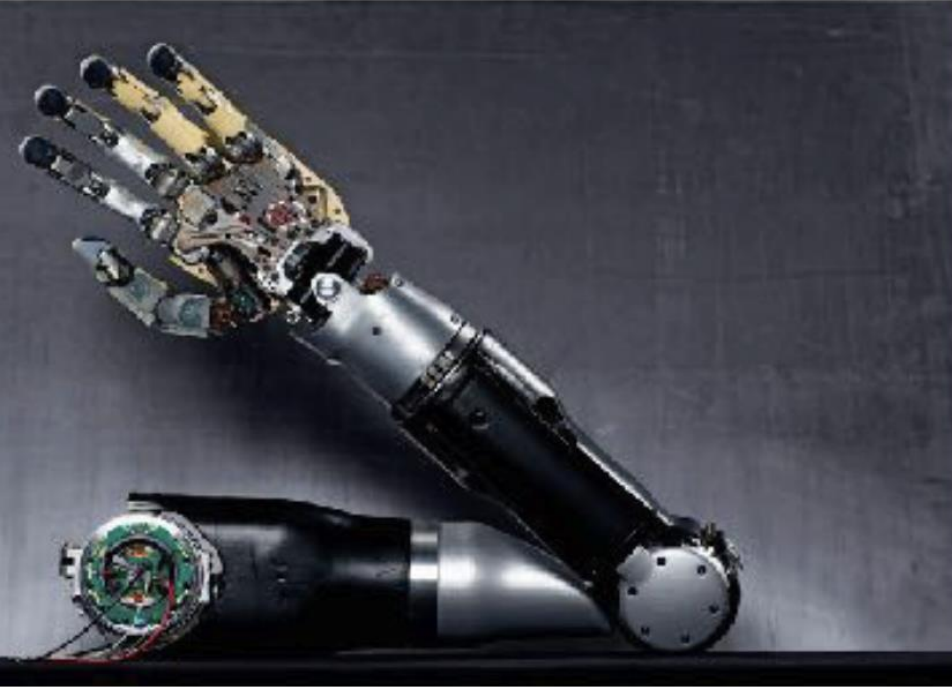

hi-tech

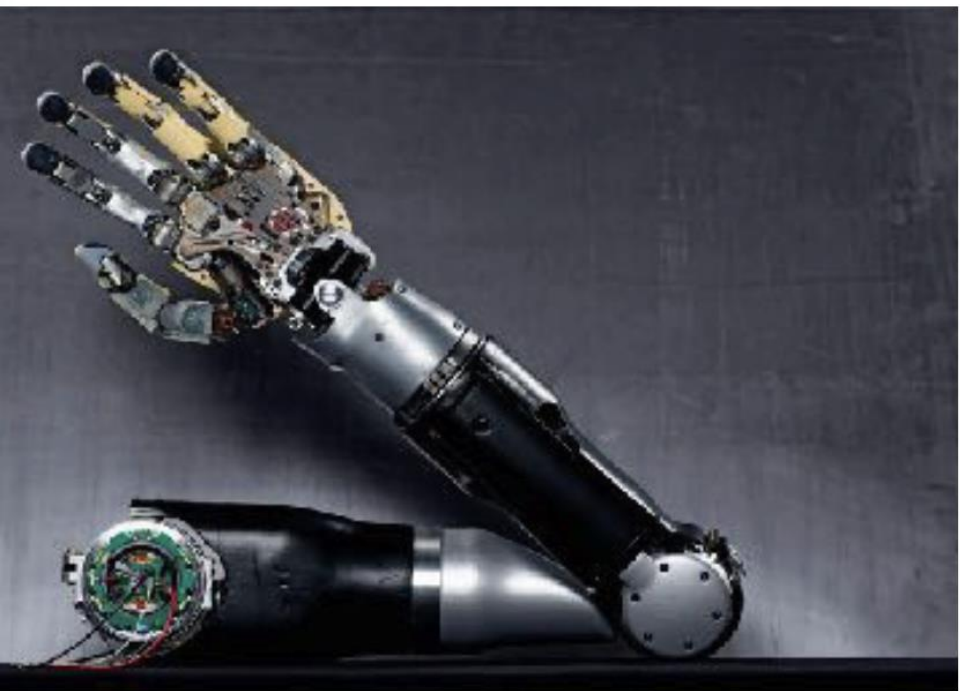

hi-tech



low-tech

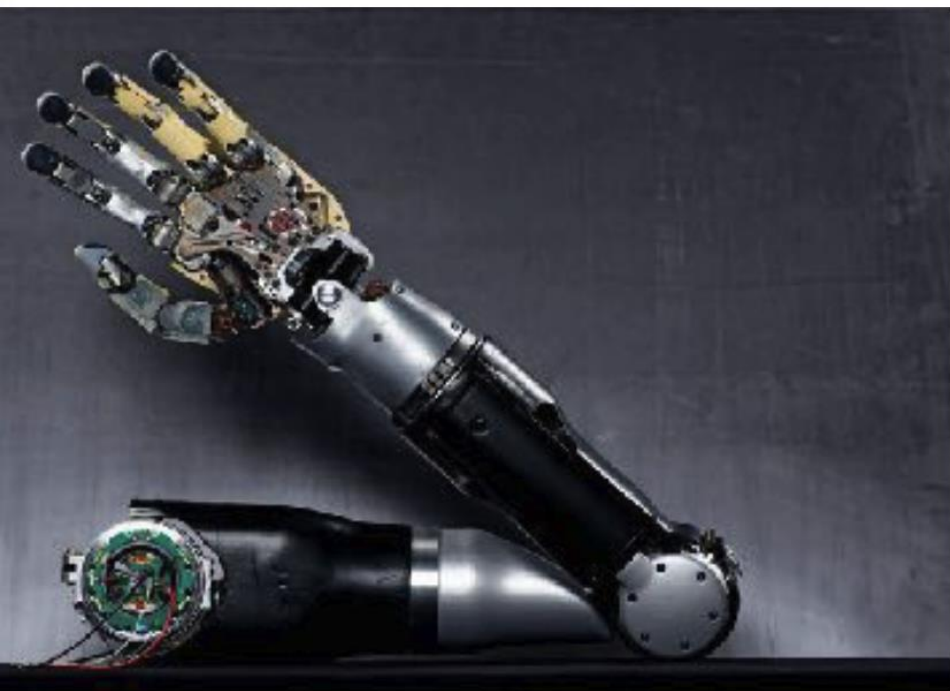

hi-tech



mid-tech



low-tech

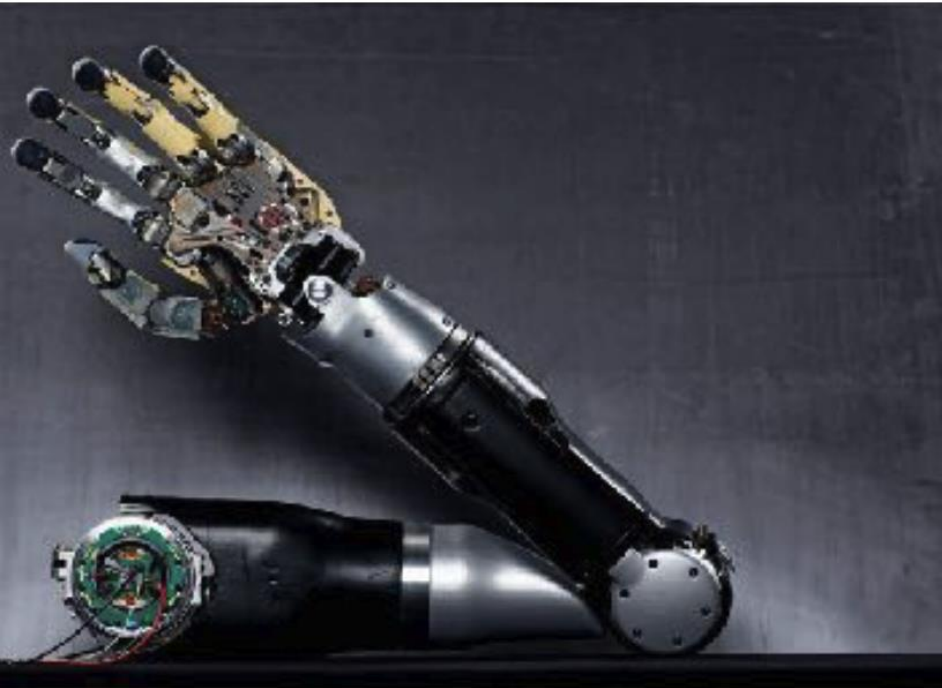

hi-tech



mid-tech



low-tech

Internet, CAD software, 3D printing
lack of electronics, use of kinetic energy,
localized manufacturing, customization & maintenance



**Digital
commons**

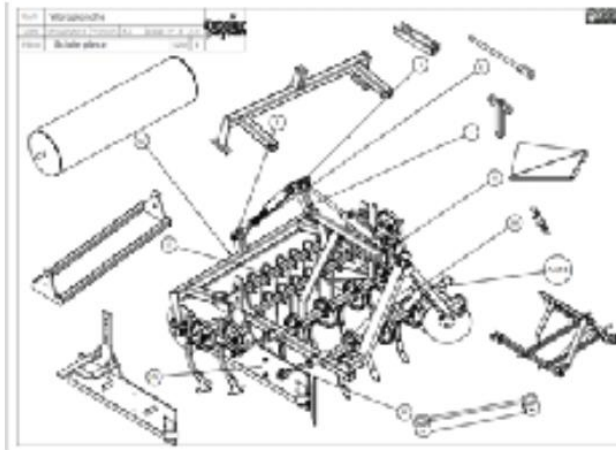

**Localized
manufacturing**





TZOUMAKERS

FARM HACK

A COMMUNITY FOR FARM INNOVATION

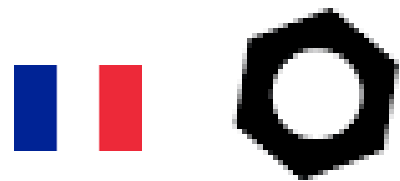

**L'atelier
paysan**

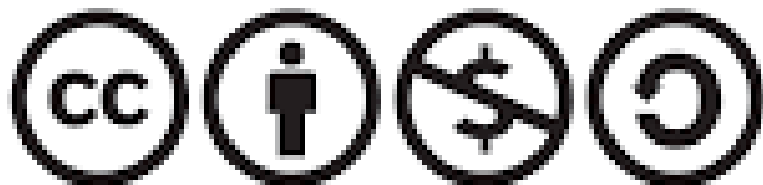



Albania

Thessaloniki

Θεσσαλονίκη

Çanakkale

Greece

Aegean Sea

Patras

Πάτρα

Athens

Αθήνα

Izmir

Archea

Olimpia

Αρχαία



Tzoumakers @ Tzoumerka, GR



Identifying needs



Participatory design
based on global digital commons



Localized manufacturing



Localized manufacturing



Testing the solution



**Digital
commons**

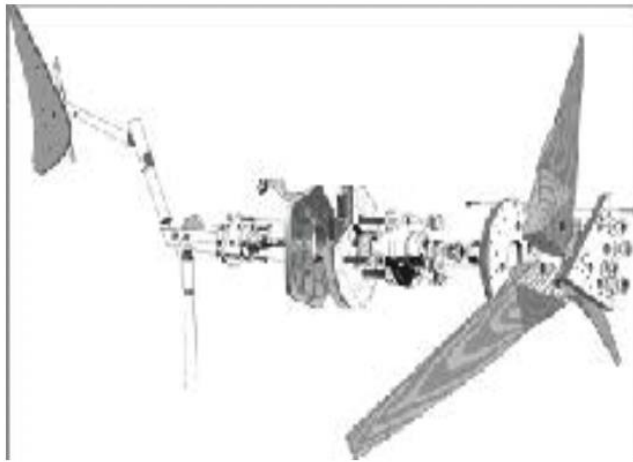

**Digital
commons**

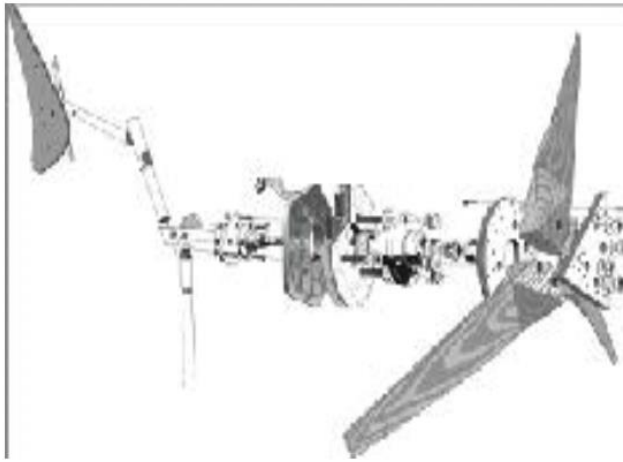

**Localized
manufacturing**









Development of highly innovative smart grid hardware and
implementation of state-of-the-art energy technologies















Electrical tool safety
DANGER
HIGH VOLTAGE









जिला प्रमुख
उप-निर्वाहक
...
...
...

पुस्तकालय

...
...
...

...

...
...
...

...

...
...
...
...
...

...

...
...
...
...
...

Vertical teal line segment

Vertical teal line segment

Vertical teal line segment

Vertical teal line segment

Vertical teal line segment

Vertical teal line segment

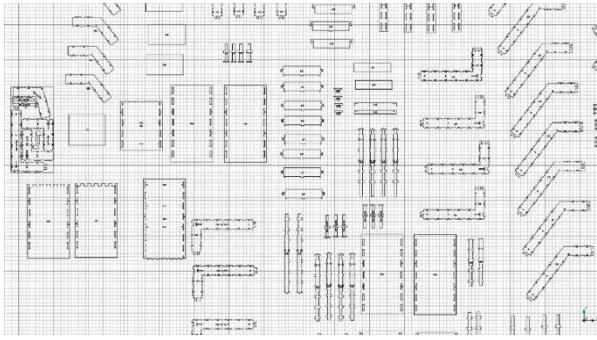

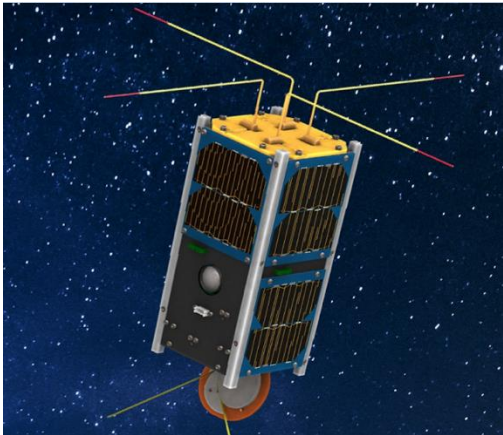
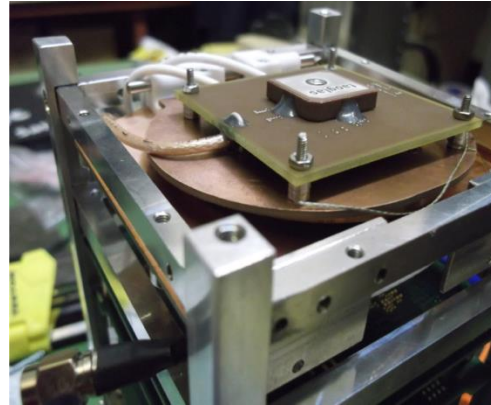
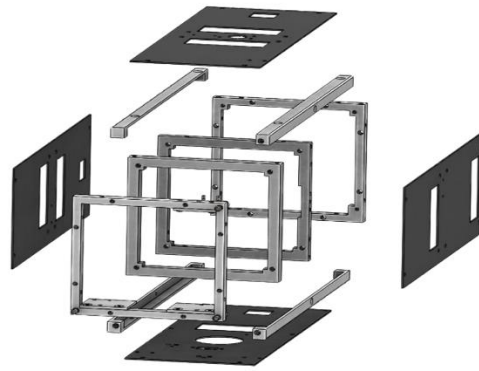
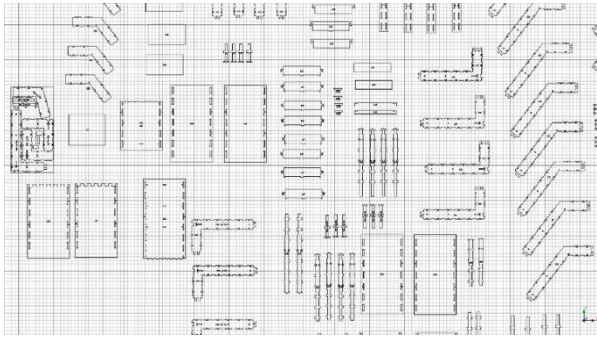

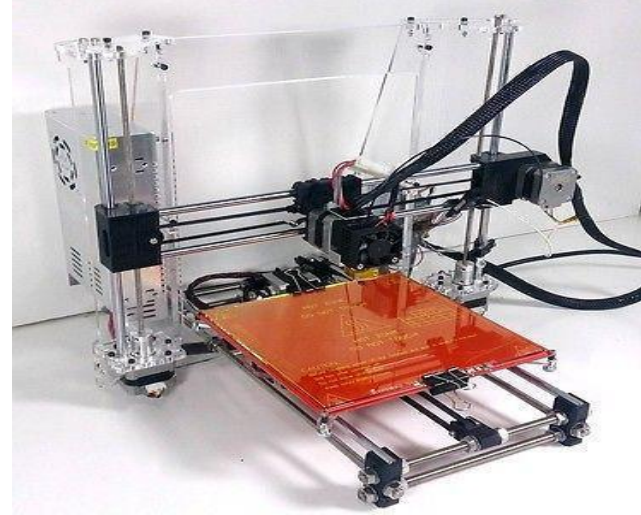
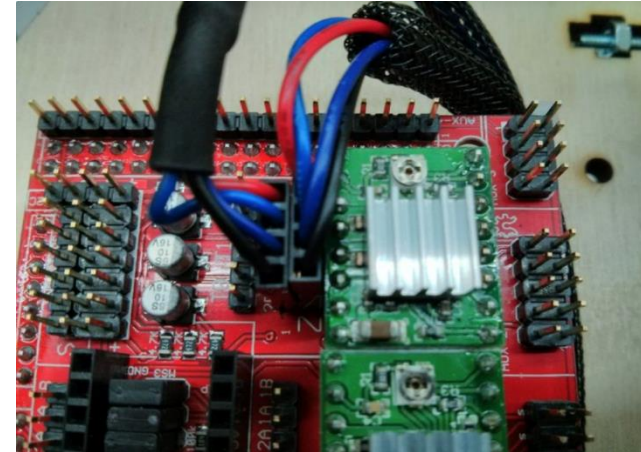
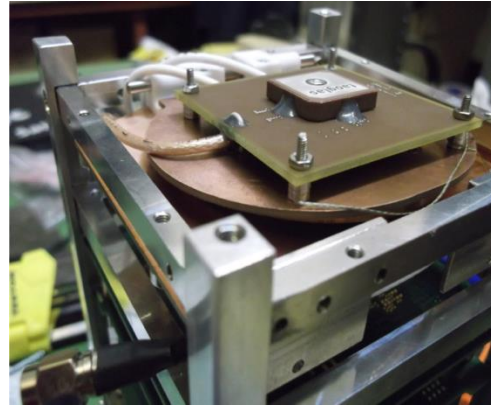
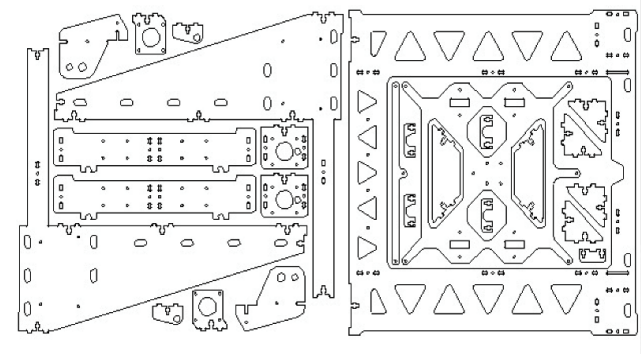
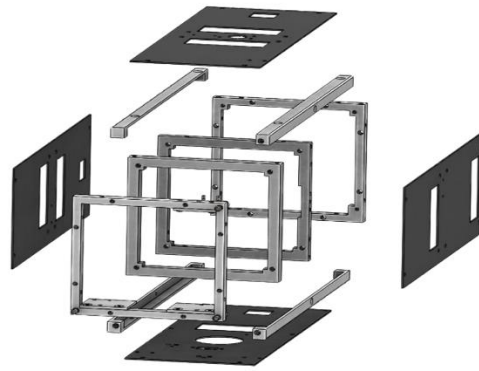
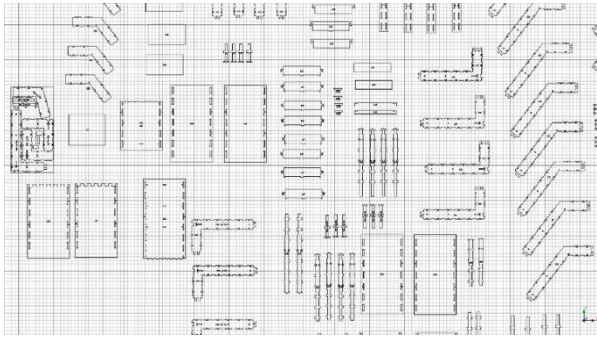



DIGITAL COMMONS
of Design, Knowledge
& Software



DIGITAL COMMONS
of Design, Knowledge
& Software





A near-future landscape*

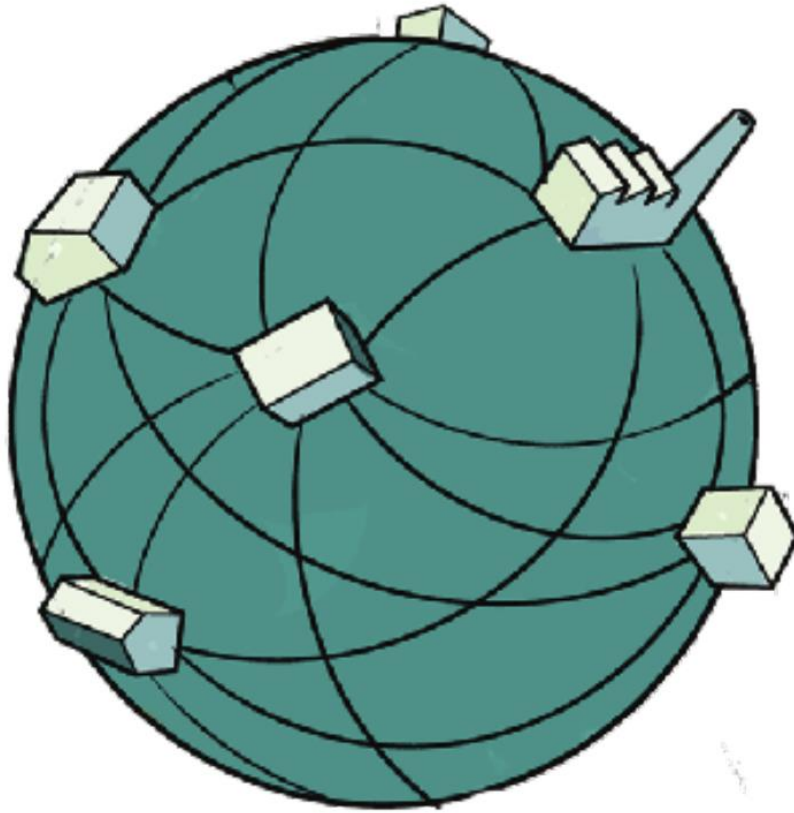

*energy

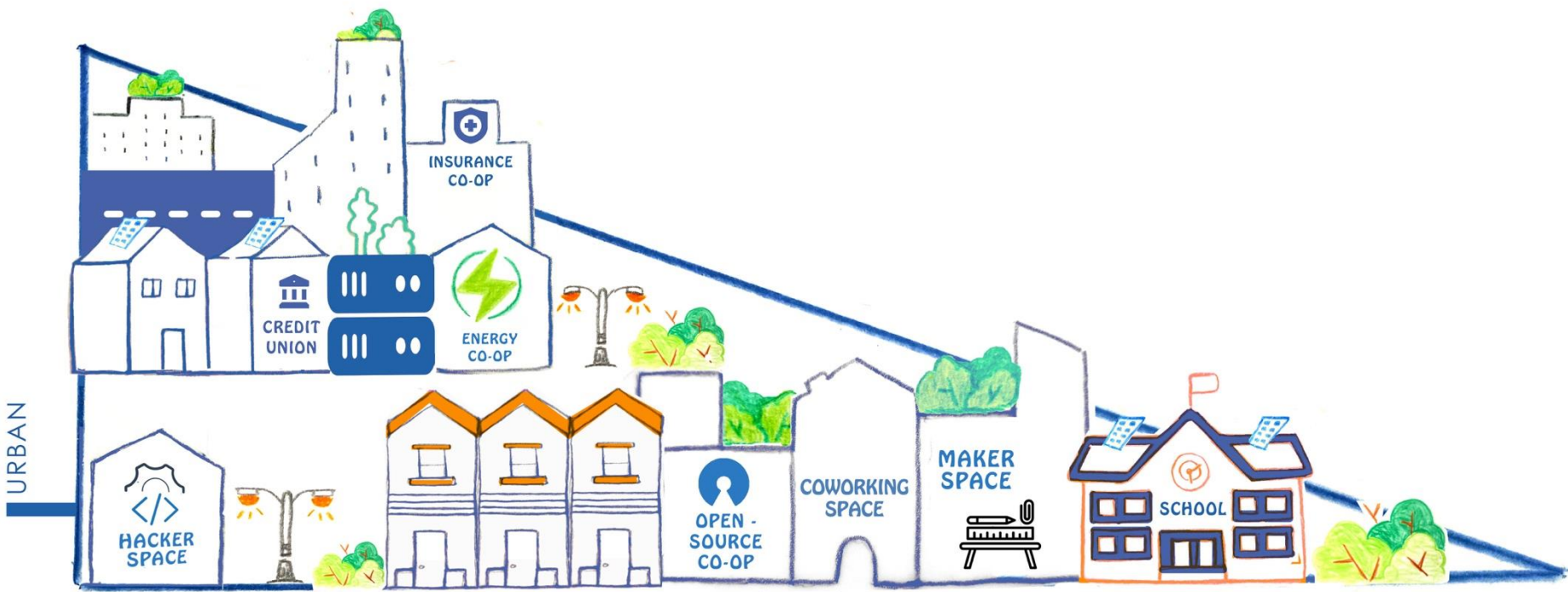



INSURANCE
CO-OP

CREDIT
UNION

ENERGY
CO-OP

HACKER
SPACE

OPEN -
SOURCE
CO-OP

COWORKING
SPACE

MAKER
SPACE

SCH

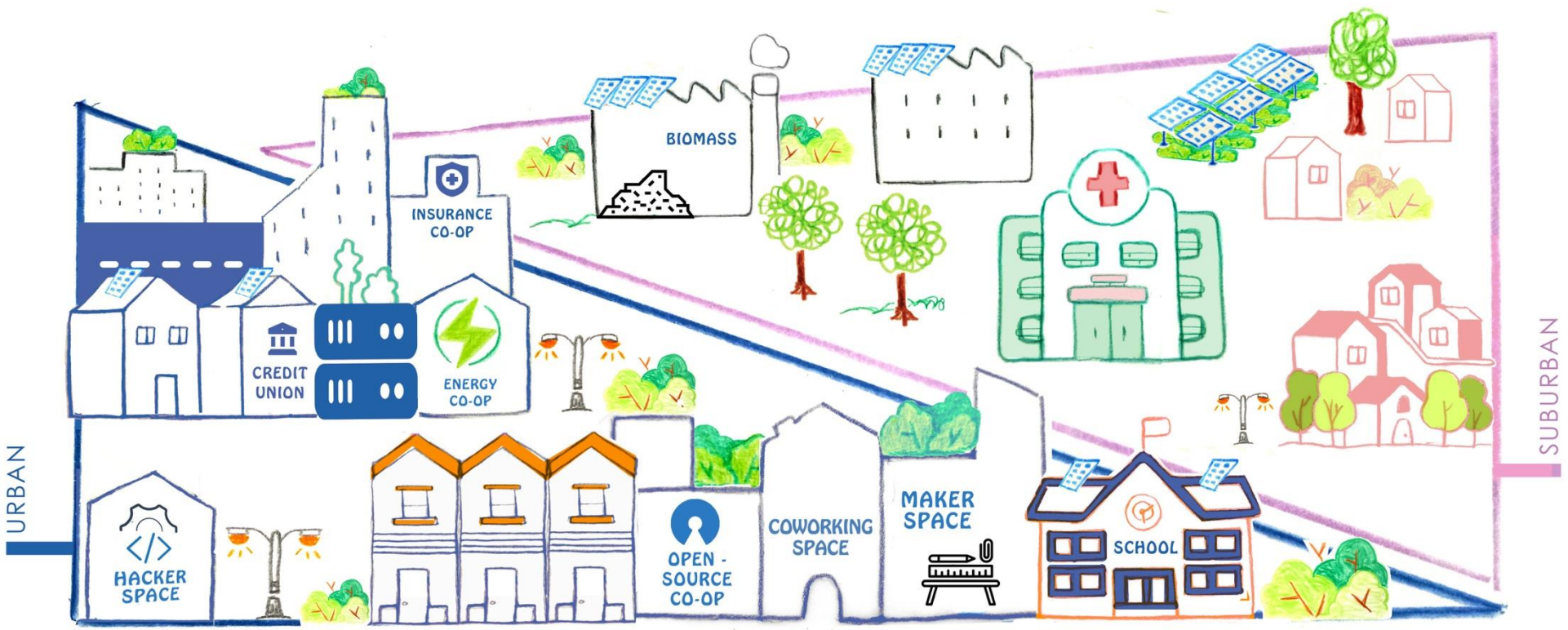

URBAN

SUBURBAN

HACKER SPACE

CREDIT UNION

INSURANCE CO-OP

ENERGY CO-OP

OPEN-SOURCE CO-OP

COWORKING SPACE

MAKER SPACE

SCHOOL

BIOMASS



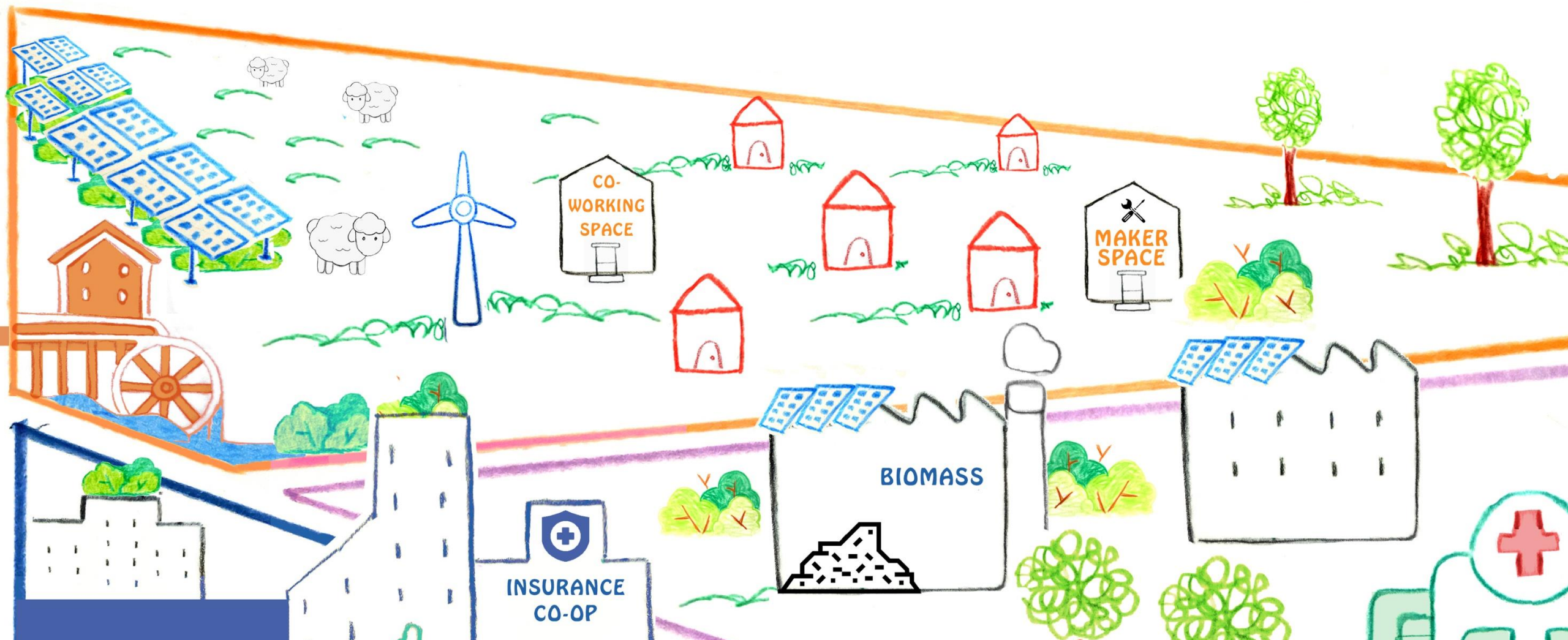

CO-WORKING SPACE

MAKER SPACE

BIOMASS

INSURANCE CO-OP





Let's discuss it!